

15000-TT, 13' Model Shown
Available 6" or 8" Standard

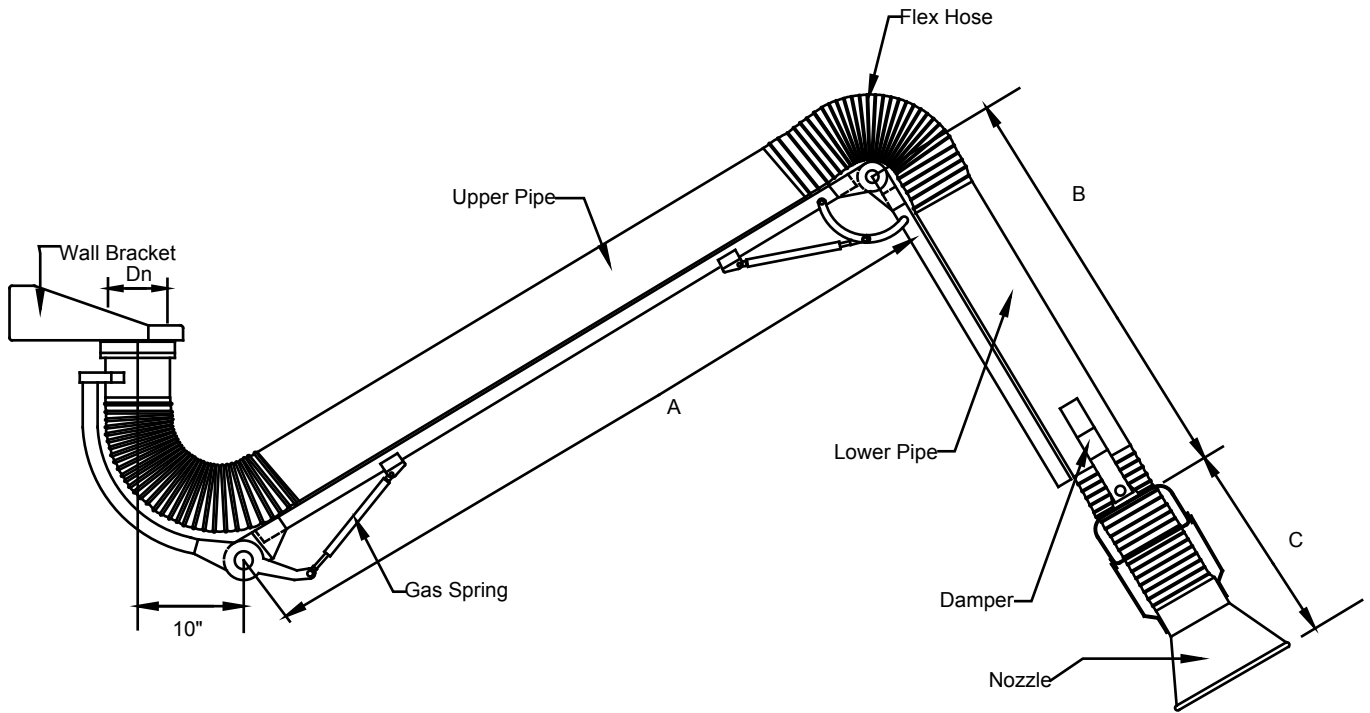

Model	A	B	C	Dn	Description
15136-TT	75.1"	41.3"	21.0"	6"	13' x 6" Tube Type Arm
15138-TT	75.1"	41.3"	21.4"	8"	13' x 8" Tube Type Arm

Arms also available in 4" or 5" diameter

Contact factory for bench-top mount, other configurations

